

Seasonal Sampler: Santa Hat Block

Find all block patterns and details about this quilt at AllPeopleQuilt.com/SeasonalSampler.
If you're making the *Seasonal Sampler*, you'll need two Santa Hat blocks.

FINISHED BLOCK: 12" square

MATERIALS

Yardages and cutting instructions are based on 42" of usable fabric width.

- 9×21" piece (fat eighth) *each* solid white, light gray print, and red print

CUT FABRICS

Cut pieces in the following order.

From solid white, cut:

- 2–6" square
- 2–3½×5" rectangle
- 4–1½" squares

From light gray print, cut:

- 1–2×12½" rectangle
- 1–3½" square

From red print, cut:

- 1–8×12½" rectangle

ASSEMBLE BLOCK

Measurements include ¼" seam allowances. Sew with right sides together unless otherwise stated.

Press seams in directions indicated by arrows on diagrams. If no direction is specified, press seam toward darker fabric.

1 Use a pencil to mark a diagonal line  on wrong side of each solid white 1½" square and 6" square.

2 Align marked solid white 1½" squares with each corner of light gray print 3½" square (**Diagram 1**; note direction of marked lines). Sew on marked lines. Trim seam allowances to ¼". Press open attached triangles to make Snowball unit. The unit still should be 3½" including seam allowances.

3 Referring to **Diagram 2**, sew together solid white 3½×5" rectangles and Snowball unit to make a hat top unit. The unit should be 3½×12½" including seam allowances.

4 Referring to **Diagram 3** for direction of marked lines, align marked solid white 6" squares with top left-hand and top right-hand corners of red print 8×12½" rectangle. Sew on marked lines. Trim seam allowances to ¼". Press open attached triangles to make hat bottom unit. The unit still should be 8×12½" including seam allowances.

5 Referring to **Diagram 4**, lay out hat top unit, hat bottom unit, and light gray print 2×12½" rectangle in a row. Sew together pieces in row to make a Santa Hat block. The block should be 12½" square including seam allowances.

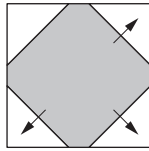
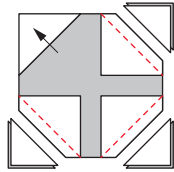
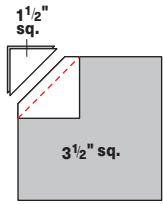

Diagram 1

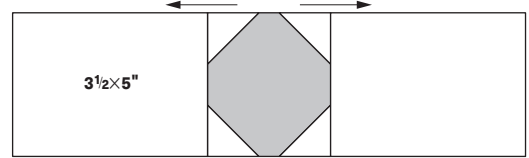

Diagram 2

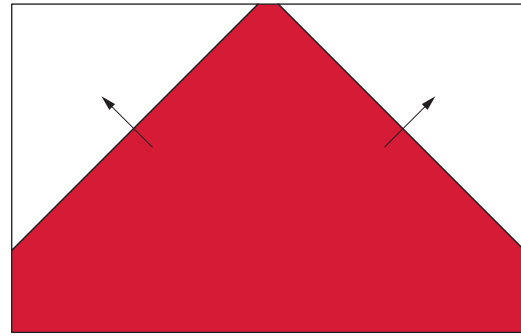
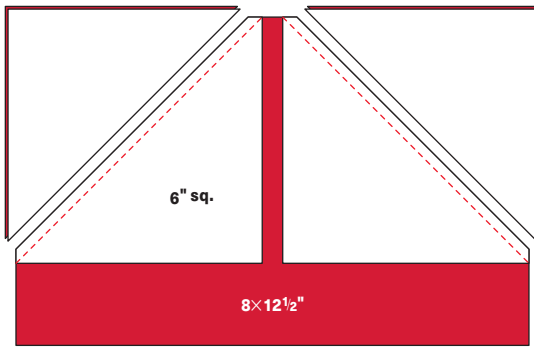

Diagram 3

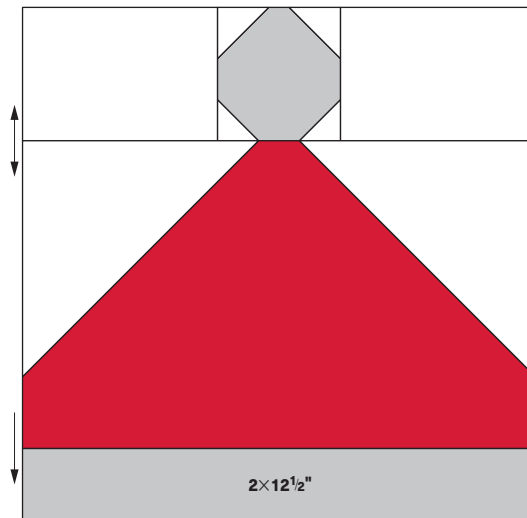

Diagram 4