

Seasonal Sampler: Santa Hat Block

This is a bonus 6" block version of the Santa Hat Block. Find all block patterns and details about this quilt at AllPeopleQuilt.com/SeasonalSampler.

FINISHED BLOCK: 6" square

MATERIALS

Yardages and cutting instructions are based on 42" of usable fabric width.

- 10" square *each* solid white, light gray print, and red print

CUT FABRICS

Cut pieces in the following order.

From solid white, cut:

- 2-3 $\frac{1}{4}$ " squares
- 2-2 \times 2 $\frac{3}{4}$ " rectangles
- 4-1" squares

From light gray print, cut:

- 1-1 $\frac{1}{4}$ \times 6 $\frac{1}{2}$ " rectangle
- 1-2" square

From red print, cut:

- 1-4 $\frac{1}{4}$ \times 6 $\frac{1}{2}$ " rectangle

ASSEMBLE BLOCK

Measurements include $\frac{1}{4}$ " seam allowances. Sew with right sides together unless otherwise stated.

Press seams in directions indicated by arrows on diagrams. If no direction is specified, press seam toward darker fabric.

1 Use a pencil to mark a diagonal line on wrong side of each solid white 1" square and 3 $\frac{1}{4}$ " square.

2 Align marked solid white 1" squares with each corner of light gray print 2" square (**Diagram 1**; note direction of marked lines). Sew on marked lines. Trim seam allowances to $\frac{1}{4}$ ". Press open attached triangles to make Snowball unit. The unit still should be 2" including seam allowances.

3 Referring to **Diagram 2**, sew together solid white 2 \times 2 $\frac{3}{4}$ " rectangles and Snowball unit to make a hat top unit. The unit should be 2 \times 6 $\frac{1}{2}$ " including seam allowances.

4 Referring to **Diagram 3** for direction of marked lines, align marked solid white 3 $\frac{1}{4}$ " squares with top left-hand and top right-hand corners of red print 4 $\frac{1}{4}$ \times 6 $\frac{1}{2}$ " rectangle. Sew on marked lines. Trim seam allowances to $\frac{1}{4}$ ". Press open attached triangles to make hat bottom unit. The unit still should be 4 $\frac{1}{4}$ \times 6 $\frac{1}{2}$ " including seam allowances.

5 Referring to **Diagram 4**, lay out hat top unit, hat bottom unit, and light gray print 1 $\frac{1}{4}$ \times 6 $\frac{1}{2}$ " rectangle in a row. Sew together pieces in row to make a Santa Hat block. The block should be 6 $\frac{1}{2}$ " square including seam allowances.

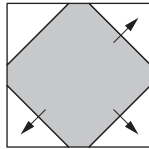
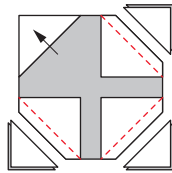
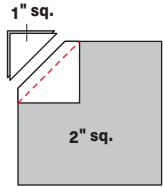

Diagram 1

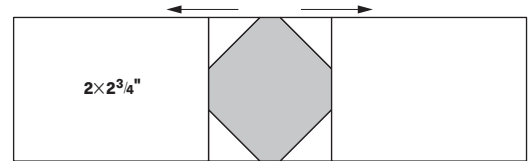

Diagram 2

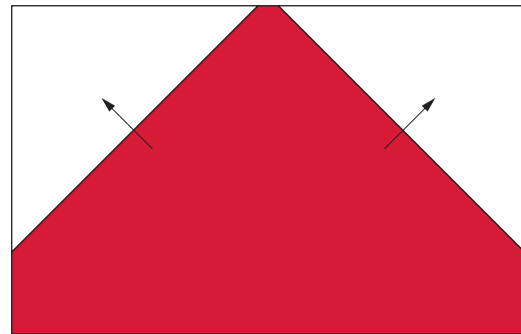
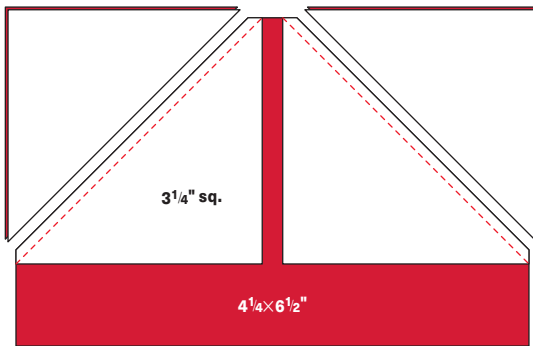

Diagram 3

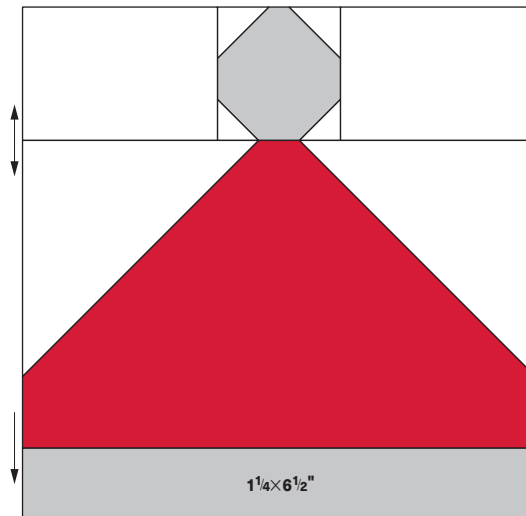

Diagram 4