

Blast from the Past Sampler: Block 22

From *Double T*, an antique quilt by an unknown maker

American Patchwork & Quilting magazine August 1997

FINISHED BLOCK: 9" square

MATERIALS

Yardages and cutting instructions are based on 42" of usable fabric width.

- 9×21" piece (fat eighth) light print
- 9×21" piece (fat eighth) medium print

CUT FABRICS

Cut pieces in the following order.

If you prefer to make triangle-squares larger than necessary and trim them to size, cut 4" squares instead of the $3\frac{7}{8}$ " squares specified here.

From light print, cut:

- 2- $3\frac{7}{8}$ " squares
- 8- $2\times 3\frac{1}{2}$ " rectangles

From medium print, cut:

- 2- $3\frac{7}{8}$ " squares
- 1- $3\frac{1}{2}$ " square
- 16-2" squares

ASSEMBLE BLOCK

Measurements include $\frac{1}{4}$ " seam allowances. Sew with right sides together unless otherwise stated.

Press seams in directions indicated by arrows on diagrams. If no direction is specified, press seam toward darker fabric.

1 Use a pencil to mark a diagonal line on wrong side of each light print $3\frac{7}{8}$ " square and medium print 2" square.

2 Referring to **Diagram 1**, layer a marked light print square atop a medium print $3\frac{7}{8}$ " square. Sew together with two seams, stitching $\frac{1}{4}$ " on each side of marked line. Cut apart on marked line. Press open to make two triangle-squares. Each triangle-square should be $3\frac{1}{2}$ " square including seam allowances. Repeat to make four triangle-squares total.

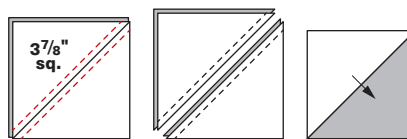

Diagram 1

3 Align a marked medium print square with one end of a light print $2\times 3\frac{1}{2}$ " rectangle (**Diagram 2**; note direction of marked line). Sew on marked line. Trim seam allowance to $\frac{1}{4}$ ". Press open attached triangle. Add a second marked medium print square to opposite end of same rectangle to make a Flying Geese unit. The unit still should be $2\times 3\frac{1}{2}$ " including seam allowances. Repeat to make eight Flying Geese units total.

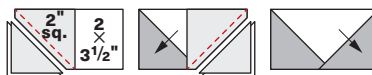

Diagram 2

4 Referring to **Diagram 3**, sew together two Flying Geese units to make a side unit. The unit should be $3\frac{1}{2}$ " square including seam allowances. Repeat to make four side units total.

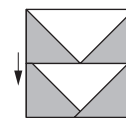

Diagram 3

5 Referring to **Diagram 4**, sew together triangle-squares, side units, and medium print $3\frac{1}{2}$ " square in three rows. Join rows to make block. The block should be $9\frac{1}{2}$ " square including seam allowances.

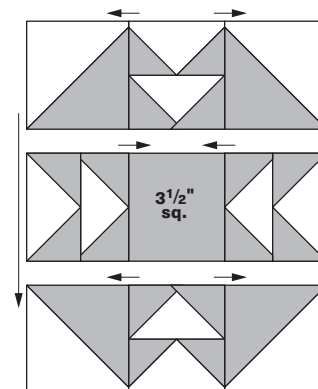
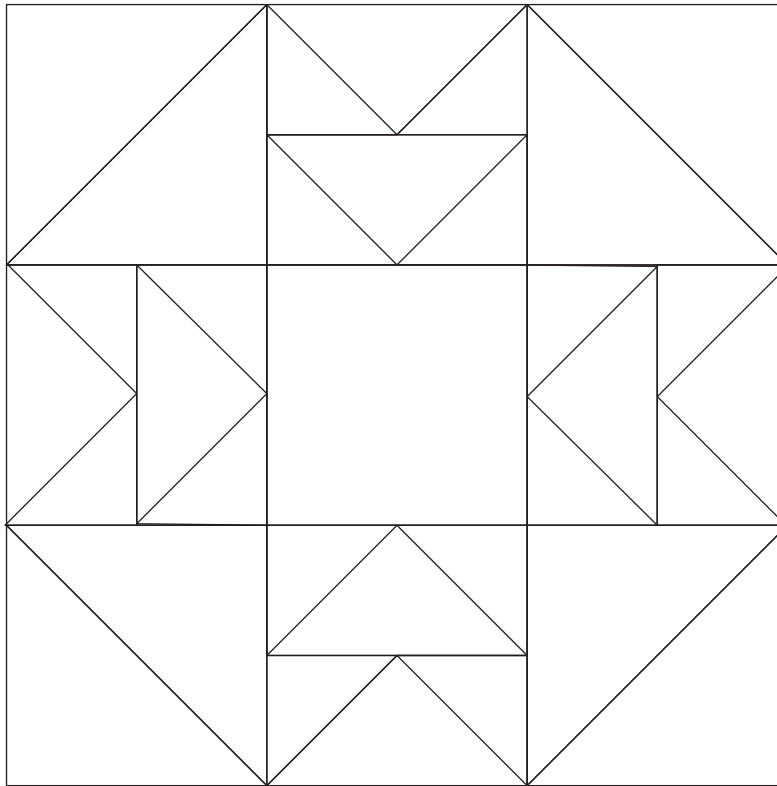
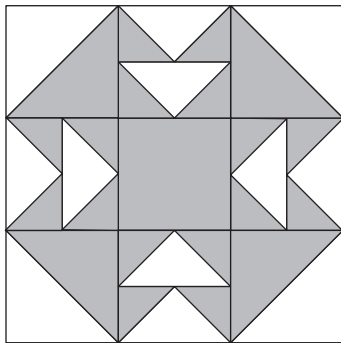

Diagram 4





Coloring Diagram



Use the Coloring Diagram, *top*, to plan your version of the original block, *above*. Audition fabric swatches using the squares, *right*.

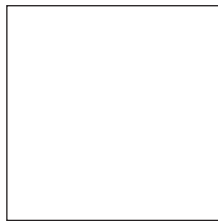

Swatch

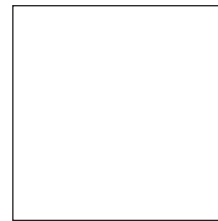

Swatch

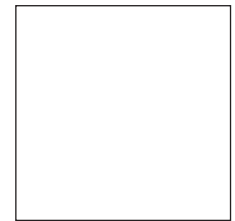

Swatch

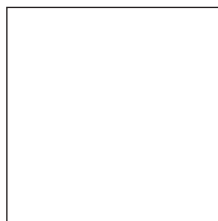

Swatch

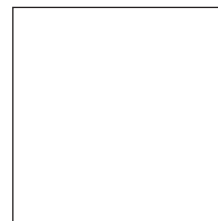

Swatch

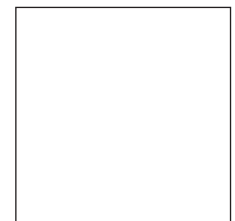

Swatch